

Tefal®

SMART CLEAN

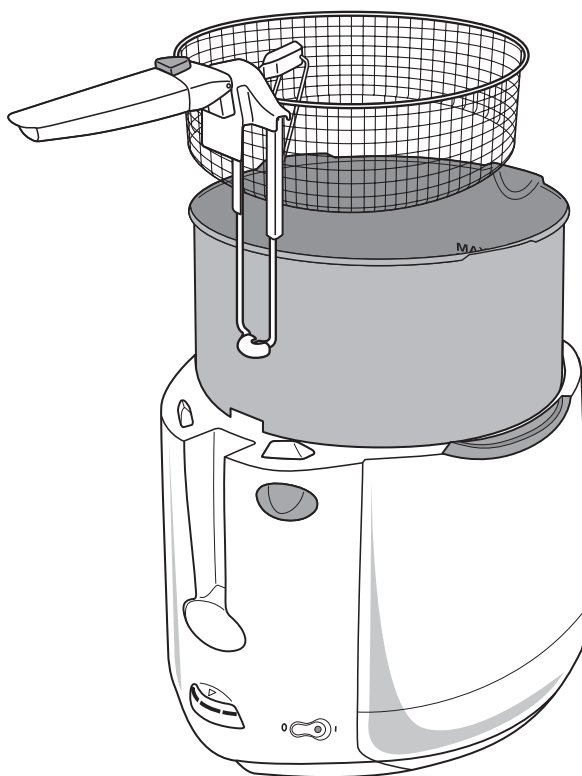

www.tefal.com

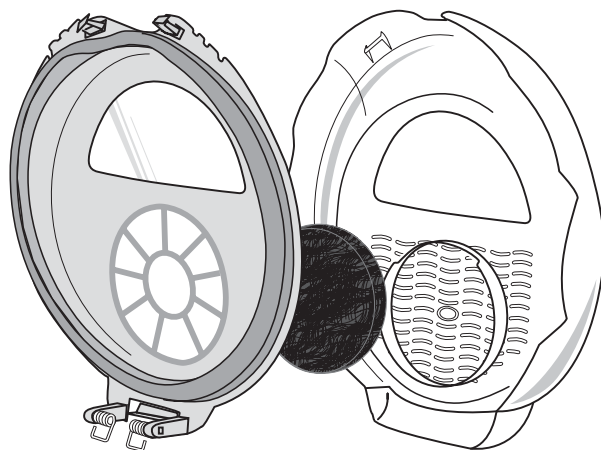

1

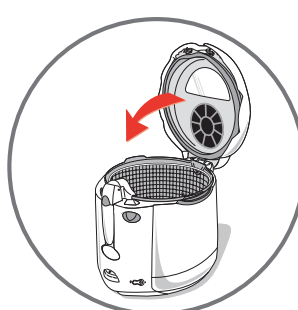
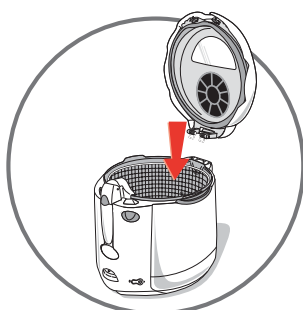
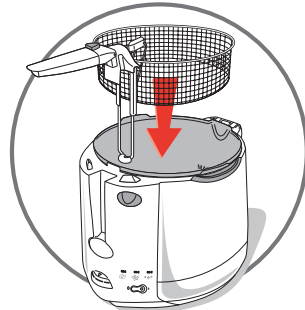
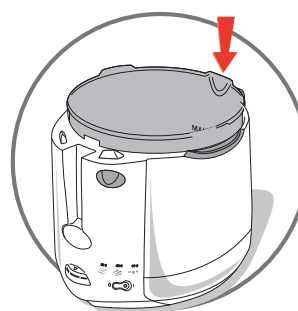
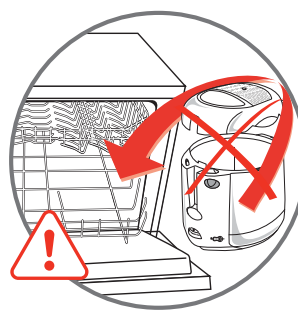
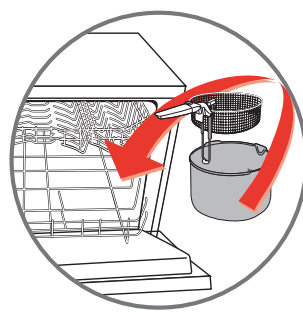
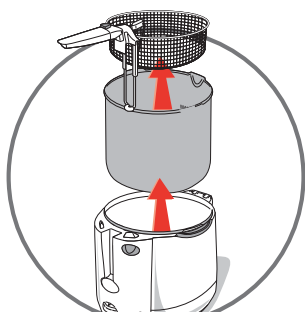
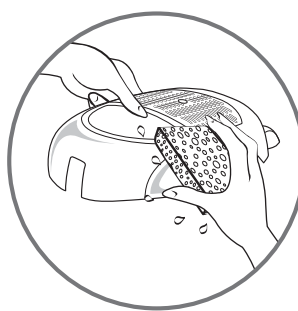
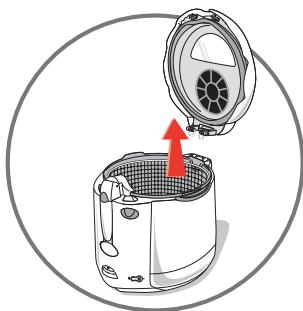
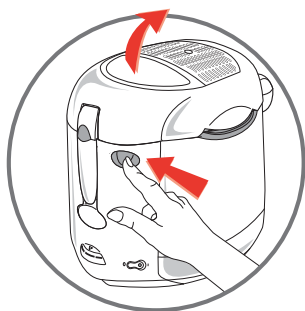
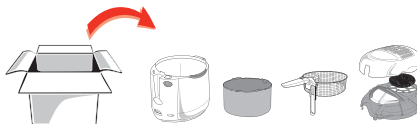

2

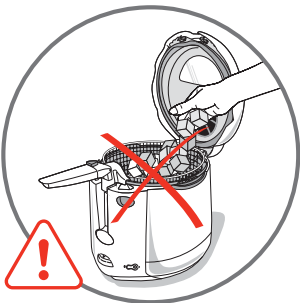
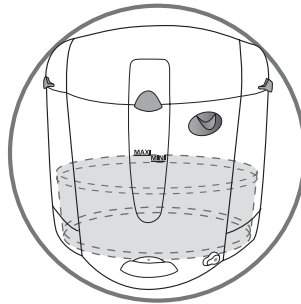
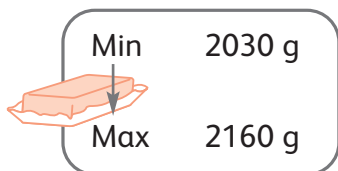
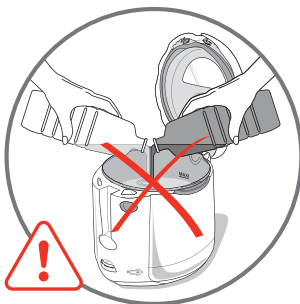
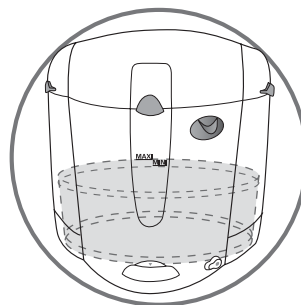
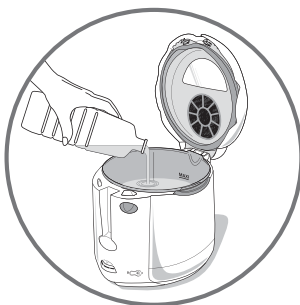
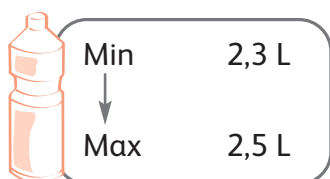

3



Max 1250 g



670 g

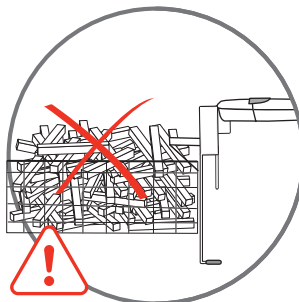
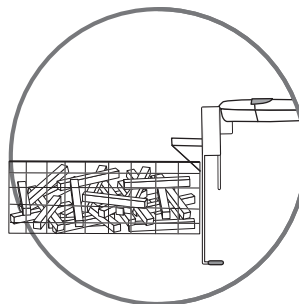
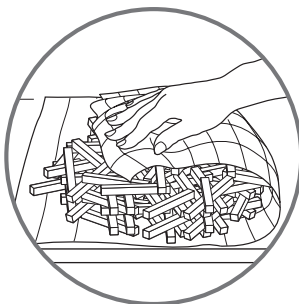

Max 900 g



500 g

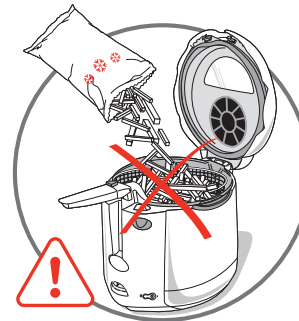
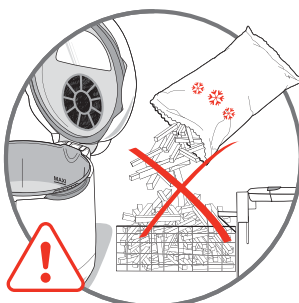
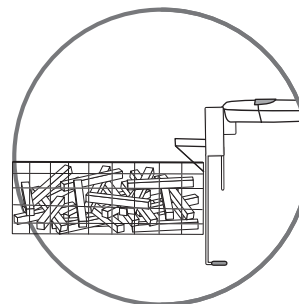

4

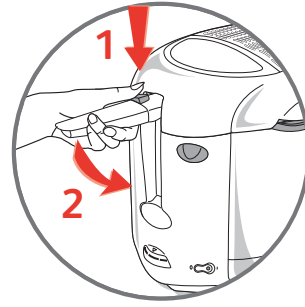
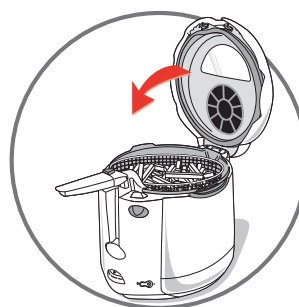
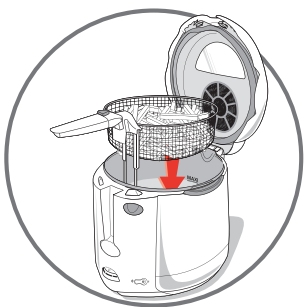
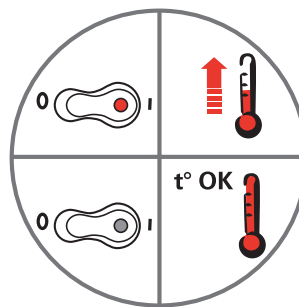
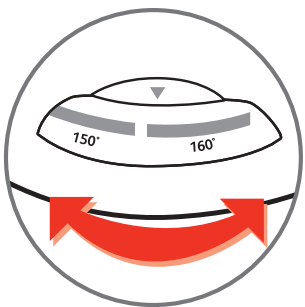
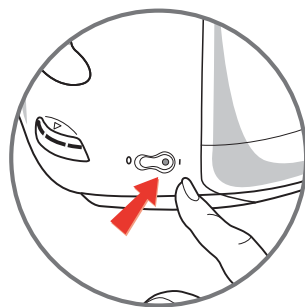
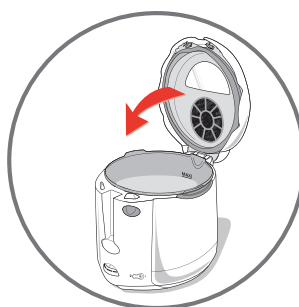
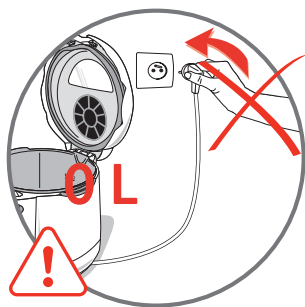
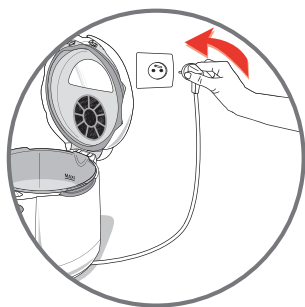

5



	670 g	170°C	13 - 15 min		
	1000 g	190°C	12 - 15 min		
	1250 g	190°C	16 - 17 min		
	500 g			190°C	8 - 9 min
	900 G			190°C	13 - 14 min
	8 - 10	190°C	8 - 9 min	190°C	10 - 13 min
	1 - 2	180°C	12 - 15 min	190°C	11-13 min
	g	190°C	min	190°C	5 - 6 min
	250 - 350 g	170°C	4 - 6 min	190°C	5 - 7 min
	250 - 300 g	170°C	10 - 12 min	170°C	6 - 8 min
	250 - 300 g			190°C	4 - 5 min
	450 - 480 g	170°C	6 - 8 min	190°C	5 - 6 min
	200 g	150°C	4 - 6 min	150°C	10 - 12 min
	g	170°C	min	170°C	5 - 6 min

6

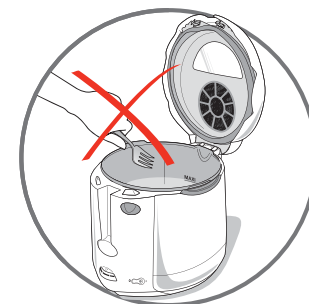
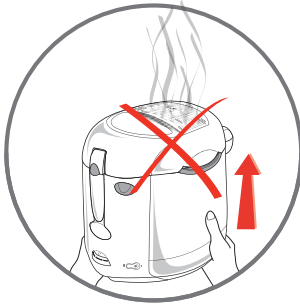
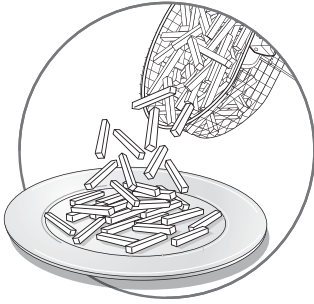
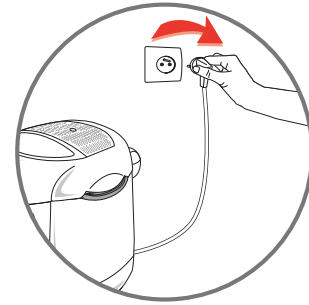
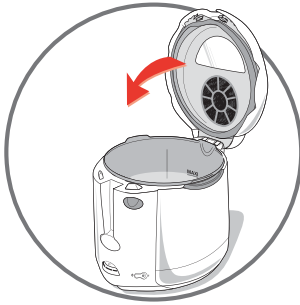
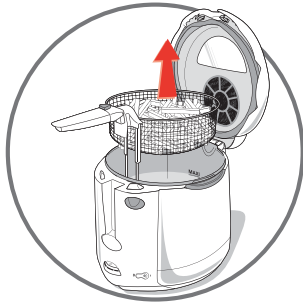
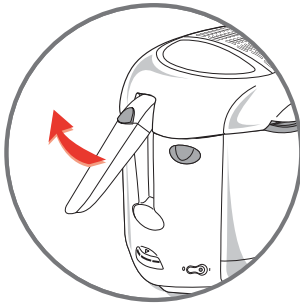
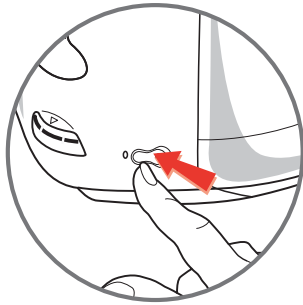

7

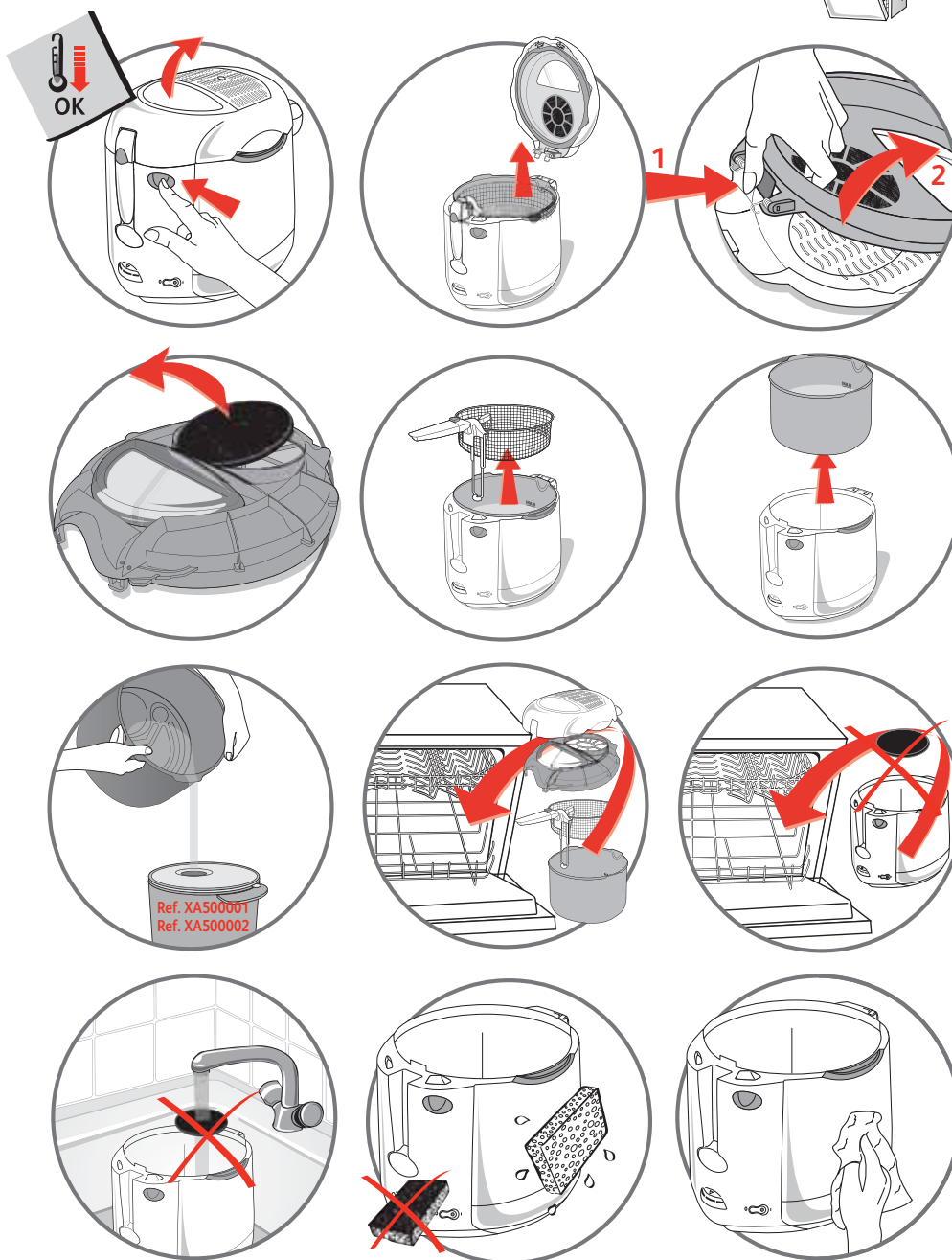
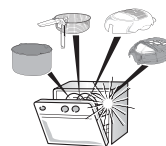

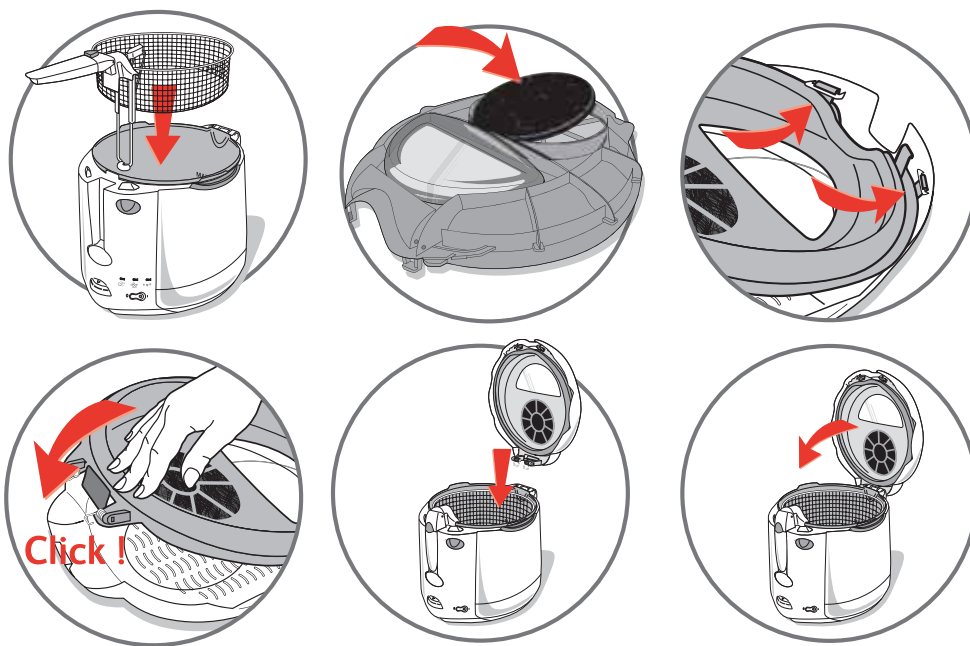

8

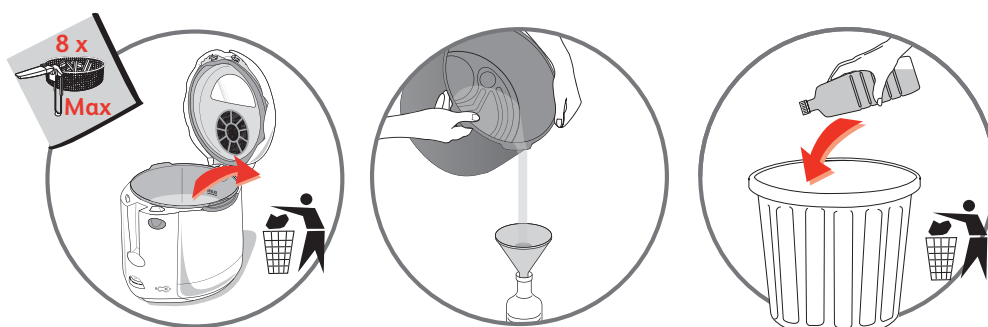
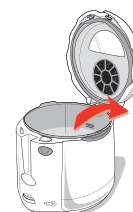

9

